

MICROSCALE

NEOCLASSICAL MONUMENT

Build this tiny Neoclassical monument using just 32 LEGO bricks. This tiny model has a domed roof, columns and a triangular pediment.

This model uses a railing to recreate four columns and a single part for the entire dome. You can use parts in different ways when you try building at a new scale.

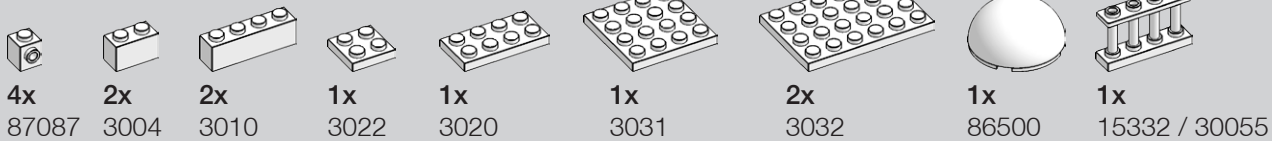
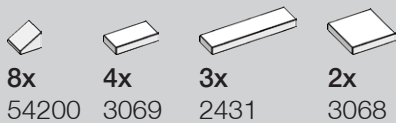
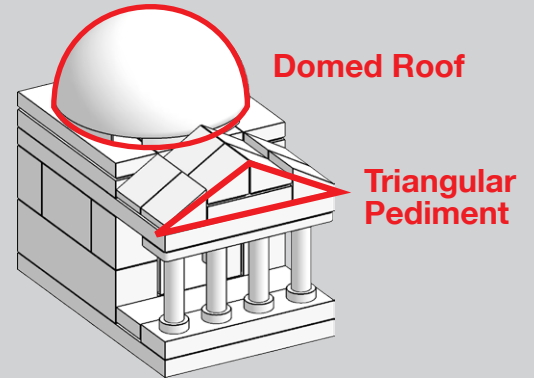

THOMAS JEFFERSON MEMORIAL
Washington, DC, 1943, John Russell Pope, Eggers & Higgins.



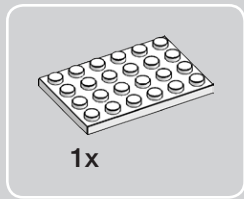

1x

1

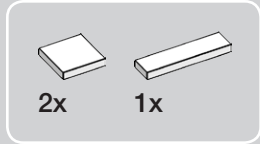
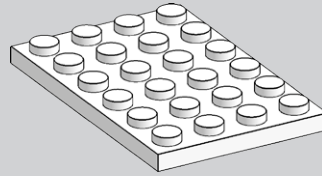

2x

1x

2

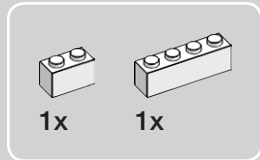
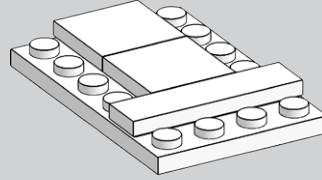

1x

1x

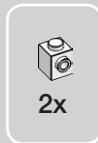

2x

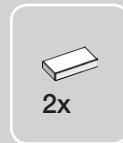

2x

1

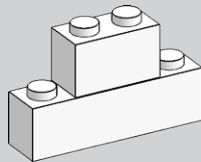

2

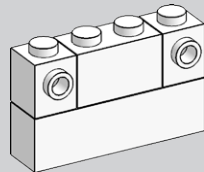

3

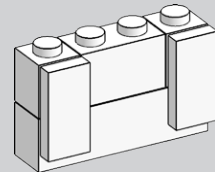

2x

3

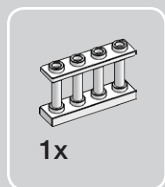
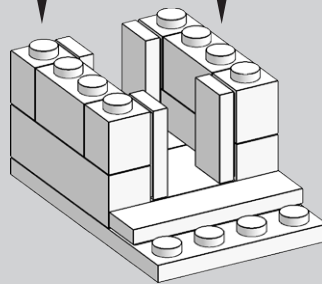

1x

4

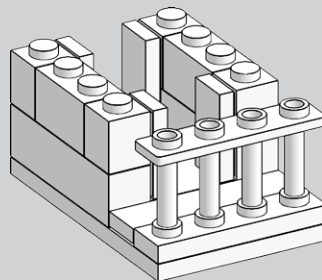

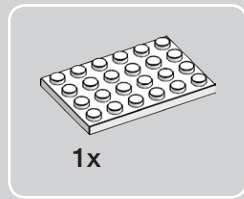

5

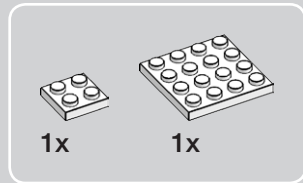
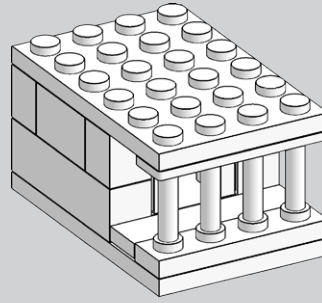

6

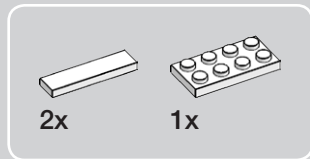
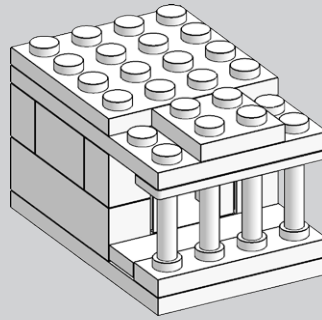

7

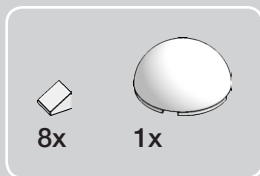
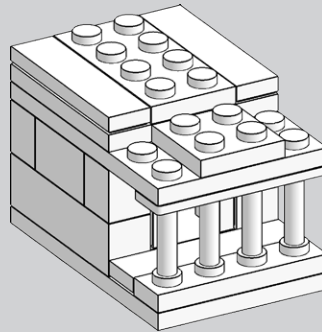

8

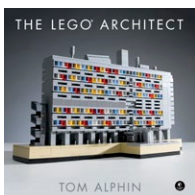
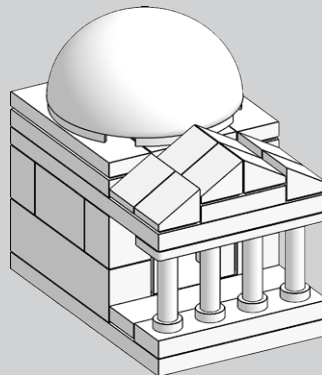

Check out my new book: **The LEGO Architect**. You'll learn about architectural styles like Art Deco, Modernism, and Brutalism. See galleries of amazing LEGO models, and instructions to build 12 detailed LEGO architectural models.